

BEFORE OPERATING CLEANER, READ ALL INSTRUCTIONS IN THIS MANUAL CAREFULLY.

Table of Contents

Maintenance, Important Electrical Information, Parts Included, Important Safety Instructions	page 2
To Operate, Maintenance	page 3
Warranty, Safeguards, Accessories, Troubleshooting Guide ..	page 4

Maintenance

Your Oreck Compact Vacuum Cleaner is a product of precise engineering. The motor bearings are permanently lubricated and should not be oiled.

Save your sales or purchase slip. Should your Oreck appliance require warranty service, present this slip to the Authorized Service Center as your proof of purchase date.

Important Electrical Information

MOTOR PROTECTION SYSTEM: If fine materials such as soot, cement, plaster dust, copy machine powder, etc. are picked up, the bag surface may seal and cause the motor to shut off to avoid overheating. If this happens, turn the switch off and unplug the cleaner. Replace filter bag. Check and clear any clogs in hose or accessories. After approximately 30 minutes the motor will have cooled and the cleaner will be ready to use.

Note: The cleaner must remain unplugged for 30 minutes for motor to cool and system to reset.

Parts Included

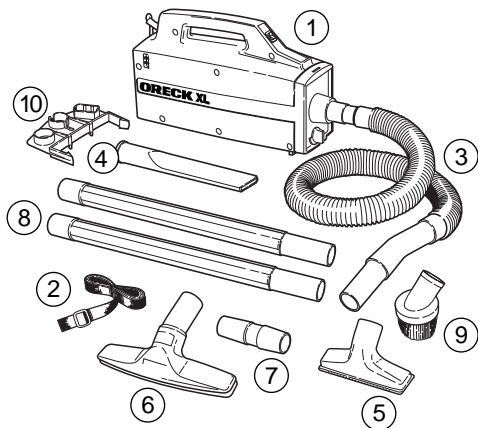

ITEM

1. Vacuum cleaner housing with paper filter bag and micro filter installed
2. Adjustable shoulder strap
3. Flexible hose with built-in adapter for easy insertion in vacuum or blower port
4. Crevice tool
5. Fabric tool
6. Bare floor and wall tool
7. Tool adapter tube for fitting tools directly to vacuum when not using hose
8. Two extension wands
9. Dusting brush
10. Tool Caddy

IMPORTANT SAFETY INSTRUCTIONS

When using an electrical appliance, basic precautions should always be followed, including the following:

**READ ALL INSTRUCTIONS BEFORE
USING THIS VACUUM CLEANER**



WARNING

**To reduce the risk of fire,
electric shock, or injury:**

- Do not leave appliance unattended when plugged in. Unplug from outlet when not in use and before servicing.
- Do not use outdoors or on wet surfaces.
- Do not allow to be used as a toy. Close attention is necessary when used by or near children.
- Use only as described in this manual.
- Do not use with damaged cord or plug. If appliance is not working as it should, has been dropped, damaged, left outdoors, or dropped into water, return it to a service center.
- Do not pull or carry by cord, use cord as a handle, close door on cord, or pull cord around sharp edges or corners. Do not run appliance over cord. Keep cord away from heated surfaces.
- Do not unplug by pulling on cord. To unplug, grasp the plug, not the cord.
- Do not handle plug or appliance with wet hands.
- Do not put any object into openings. Do not use with any opening blocked; keep free of dust, lint, hair and anything else that may reduce air flow.
- Keep hair, loose clothing, fingers and all parts of body away from openings and moving parts.
- Do not use to pick up anything that is burning or smoking, such as cigarettes, matches, or hot ashes.
- Do not use without filter bag assembly in place.
- Turn off all controls before unplugging.
- Use extra care when cleaning on stairs.
- Do not use to pick up flammable or combustible liquids, such as gasoline, or use in areas where they may be present.

SAVE THESE INSTRUCTIONS
Household Use Only

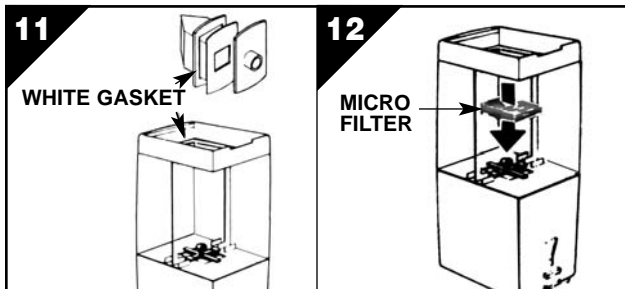
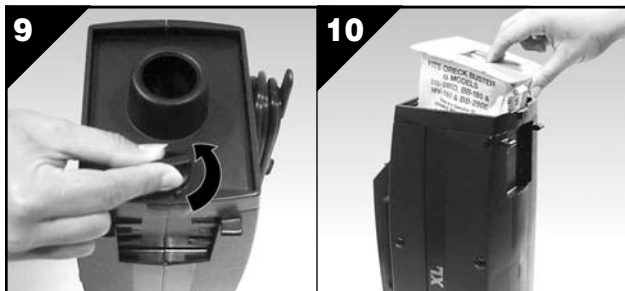
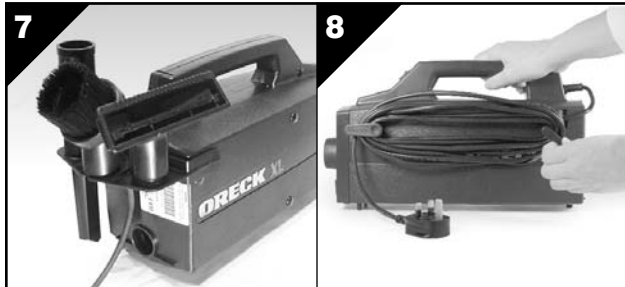
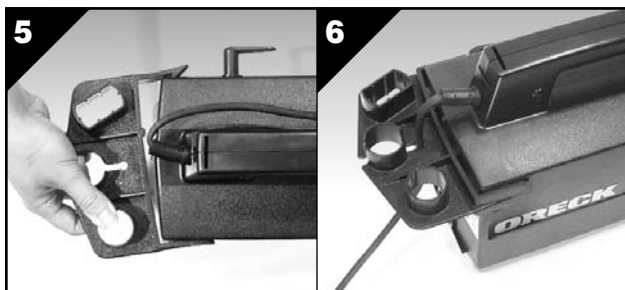
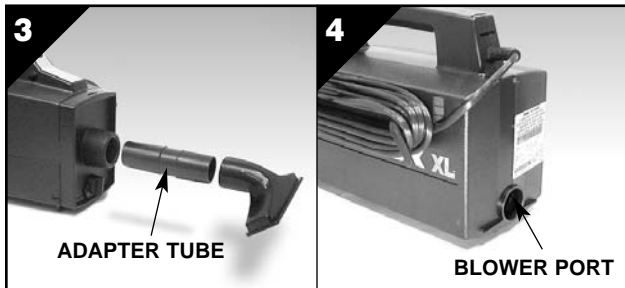
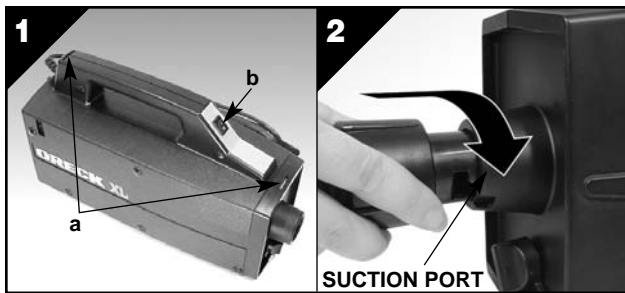

To Operate

Plug cord into electrical outlet.

Shoulder Strap

fig. 1a Insert end of shoulder strap into slot in front of On/Off power switch. Pull through three to four inches and insert into plastic clip. One inch of strap must be completely through clip. Insert other end of strap through slot located at back of handle. Insert end into clip and pull through. Adjust length by pulling strap through clip. Strap must go through both front and back clips.

IMPORTANT: Before using shoulder strap, pull both ends to be sure it is secure.

Power Switch

fig. 1b Push the power switch located on handle to the "ON" (I) position.

Hose & Tool Installation

fig. 2 The flexible hose uses a Shurlock™ locking system that prevents hose removal unless intended. To install hose, align "J" slot in hose coupling with tab inside the suction port. Insert hose in port. Twist collar clockwise to lock hose coupling in port. Twist counterclockwise and pull to remove hose.

fig. 3 NOTE: When installing tools directly to blower or suction port without using hose, tool adapter tube must be used.

Blower Port

fig. 4 The blower port is located at the rear of the machine. Installation of tools is the same as described for suction port.

Attach Caddy and Insert Tools

fig. 5 Locate caddy clip indents at top rear corners of appliance. Place appliance on firm, nonslip surface or hold in your lap. Grasp handle firmly. Place end of caddy in outside indent then strongly push and pull other end of caddy into opposite indent. Be sure rims on caddy openings face up. Avoid trapping fingers when caddy snaps on; painful pinch could result. If caddy needs to be removed, a large flat-head screwdriver inserted under caddy clip at indent can be used to carefully pry caddy loose.

fig. 6 Pull cord through center opening in caddy and push until it is seated at back of slot at rear of center opening in caddy.

fig. 7 Insert crevice tool, brush and fabric tool into caddy in spaces provided.

Cord Dump

fig. 8 Twist cord dump to easily release stored cord.

Maintenance

Changing the Filter Bag

fig. 9 Use only genuine Oreck XL filter bags. Stand unit on its back. Twist knob counterclockwise to release front plate. Lift out front plate.

fig. 10 Remove used bag and insert fresh bag. The cardboard rim fits smoothly into the recessed top.

fig. 9 Replace the front plate and close unit by turning knob clockwise.

fig. 11 IMPORTANT: The white gasket glued in the housing must be in place or unit will not operate properly. Replace if needed.

Replacing Micro Filter

Stand unit on its back.

fig. 9 Stand unit on its back. Twist knob and lift out front plate.

fig. 10 Remove disposable bag.

fig. 12 Remove old filter from bottom inside unit. Replace with new filter.

A replacement filter is supplied in each package of 12 Oreck XL filter bags or you may order filters separately.

Warranty

Alexander Nevsky Enterprises Inc. warrants the normal use of electrical products during the warranty period if such products were used in accordance with the user's guide instructions.

The product must be purchased from Alexander Nevsky Enterprises Inc. or a retail dealer authorized by Alexander Nevsky Enterprises Inc. If you purchase this product from any other source, Alexander Nevsky Enterprises Inc. grants you no warranty and you, not Alexander Nevsky Enterprises Inc., assume the entire responsibility for the quality of this product including the entire cost of any necessary servicing or repairs of any defects.

The warranty period is three (3) years; ten years (10) for the housing. The duration of your warranty period begins with the day of your purchase with the condition that you have a correctly completed warranty certificate and only under the conditions of normal domestic use. If the product is used for commercial purposes as in restaurants, café's, hotels, etc. this limited warranty is automatically voided.

At your demand, any service center authorized by Alexander Nevsky Enterprises Inc. will replace and/or repair all manufacturer's defects free of charge during the warranty period. Information about our service centers in your region can be obtained from your sales person.

ATTENTION!

Be sure to check the accuracy of the warranty certificate, the signature of the sales person, the correct date of purchase and stamp on the warranty certificate!

This warranty doesn't apply in cases of:

- abuse
- misuse
- incorrect warranty certificate or if changes have been made to the warranty certificate
- intentional damage to product or the traces of inappropriate chemical agents
- damages made by animals or insects
- the use of incorrect voltage other than indicated on the serial number plate
- using the product in a different manner than it was produced for
- repairs, other intrusive procedures or the disassembling of the unit performed by non-authorized repair facilities
- using other than manufacturer replacement parts
- damages caused by fire, flood or other reasons which are out of the control of the manufacturer or the sales person of this product

Drive belts, revolving brushes, bulbs, disposable bags and other parts subject to normal wear are not covered by this warranty. The amount of warranty repairs cannot exceed the original purchase price..

Safeguards



WARNING: Unplug cord from electrical outlet before servicing.

- **IMPORTANT: Make sure filter bag is in place.** Do not operate cleaner without filter bag. Damage to motor may occur.
- Be sure bag gasket is in place. If the white bag gasket is damaged or lost, replace at once.
(Part No. 72017-02)
- For best results, change disposable filter bag regularly even if it is not completely full. An extremely dirty bag or a bag close to full will affect the suction of the cleaner and can create excessive motor heat that could damage the motor. A good practice is to change filter bag every 30 days even if it is not full.

- Do not pick up moist material or liquids.
- If fine materials such as soot, cement, plaster dust, copy machine powder, etc. are picked up, the bag surface may seal and suction will be reduced. Change bag when this occurs.
- Clean the disposable bag cavity and the outside of the canister with a damp (not wet) cloth.

Accessories

ITEM	PART #
1. Replacement Germastat® Treated Filter Bags 12 Pk. with 1 Micro Filter	PKBB12DW
2. Replacement Micro Filter	72005-01
3. Replacement White Bag Gasket	72017-02
4. Fresh Air Tabs	AIRTAB5

Troubleshooting Guide

WARNING: Unplug cord from electrical outlet before servicing

PROBLEM	POSSIBLE SOURCE	AREAS TO CHECK
CLEANER WILL NOT RUN	Not plugged in properly. No electricity in wall outlet. Needs Service.	Be sure cleaner is firmly plugged into wall outlet. Check electrical source—fuse or circuit breaker. Take to service center or call for nearest service center.
CLEANER DOES NOT PICK UP OR HAS LOW SUCTION	Filter bag is full. Hose / Wand tool is clogged. Air leak due to missing or damaged gasket.	Replace filter bag. See "To Replace Paper Filter Bag." Clear obstruction. Replace Gasket

ALL OTHER SERVICING SHOULD BE DONE BY AN AUTHORIZED SERVICE CENTER.